



SIRUI

Professional Photographic Equipment



Tripod Kits

NEW! T-004X/024X



3T-35



T-P Series



Photo/Video Monopods



P-426S

Specialty Heads



VA-5



PH-20

Ball Heads



K-40X

QR Plates



TY-50



Address: 111 Asia Place, Carlstadt, NJ 07072
Phone: 201.939.7722

www.argraph.com

Twitter: @argraph



SIRUI 6-YEAR U.S. WARRANTY ONLY HONORED WHEN PURCHASED FROM A U.S. AUTHORIZED DEALER

SIRUI T-0X SERIES ULTRA-COMPACT TRIPOD KIT

Ultra-compact tripod kit for today's compact digital point & shoot cameras, DSLRs and camcorders



T-0X Series

NEW! T-004X / 024X Series



Tripod inverts for low angle shots



Legs fold up 180° for extra compactness



T-005X / 025X Series



**T-004/024X Folds to 15.7"
T-005/025X Folds to 12.2"**



Gets down low for table-top shots



The SIRUI T-0X Series Tripod Kit is specially designed for today's compact point and shoot digital cameras, 4/3 Mirrorless cameras, compact DSLRs and camcorders.

The SIRUI T-0X Aluminum series tripods come in Blue, Red or Black, weigh only 2.5 lb (1.12 kg) for the T-004X / 2.3 lb (1.02 kg) for the T-005X and hold up to 13.2 lb (6 kg) / 8.8 lb (4 kg) respectively. The SIRUI T-024X and T-025X tripods get their light weight - only 2 lb (0.92 kg), increased load capacity up to 13.2 lb (6 kg), impressive stability and reduced vibration characteristics from their 8-layer 100% Carbon Fiber legs.

The SIRUI T-0X's compact size when folded is up to 20% smaller than other similar style tripods. There's always room for one of these tiny wonders in your bag or backpack! Even though they're lightweight and compact, T-004X/024X tripods can still extend to over 58.2in (1478mm) * - perfect for most shooting situations.

The SIRUI T-004X/024X has an adjustable center column that moves up and down for fast and easy height adjustment. The included short center column lets you get as close as 4.9 in (125mm) to the ground. The larger spider provides increased stability.

The SIRUI T-005X/025X has a removable center column that allows you to place the ball head directly onto the spider. To guarantee long life, the attachment point for the center column is corrosion-resistant brass. This converts the SIRUI T-005X/025X into a convenient table-top tripod, plus, when you set the legs to the widest angle, you can get as close as 4.1in (104mm) to the ground!

The 3 leg angle positions are easy to adjust and provide maximum flexibility and control on uneven terrain. The 1/2 turn leg locks make setup and breakdown fast and easy. Precision manufacturing lets you effortlessly open and close the legs and provides impressive stability. Like the entire line of SIRUI tripods, there is no compromise in quality. Aluminum alloy parts are high temperature forged for maximum strength and SIRUI's custom anodized surface treatment insures superior wear and corrosion resistance.

The SIRUI T-0X tripod kit includes the SIRUI C-10X - a high quality compact ball head that perfectly complements the tripod. The ball head has an anodized surface that provides excellent resistance to scratches and corrosion. It comes in 3 colors that match SIRUI T-004X/005X tripods. The rugged SIRUI C-10X Ball Head has separate knobs for panning and main lock for added control and creativity. The SIRUI C-10X Ball Head has an Arca-compatible Quick Release plate system for total flexibility and includes a SIRUI Quick Release Plate.

Features

1. Ultra compact - 15.7in (380mm) for T-004/024 Series, 12.2in (310mm) for T-005/025 Series
2. Legs fold up 180° for extra compactness
3. For speed and convenience, each leg has an automatic leg angle lock mechanism
4. Three position leg angle for uneven terrain
5. Your choice of economical aluminum or lightweight 8-layer 100% carbon fiber
6. Short center column (included) for macro and low-angle shooting (T-004X/024X only)
7. Adjustable center column moves up and down for fast, easy height adjustments (T-004X/024X only)
8. Removable center column allows for table-top use and low-angle shooting (T-005X/025X)
9. Forged for greater strength and reduced weight
10. Hook on bottom of the tripod can also hold a weight bag for increased stability

**T004XR
RED**

**T004XL
BLUE**

**T004XK
BLACK**

**T024X
CARBON**

**T005XR
RED**

**T005XL
BLUE**

**T005XK
BLACK**

**T025X
CARBON**

What's included:
Tripod, C-10X Ball Head
TY-C-10 quick release plate,
custom soft case, tools,
instruction manual, warranty card

Watch the T-0X Video
<http://bit.ly/T-025X>

T-0X SERIES TRIPOD KITS

Item #	Sirui Model #	Materials	# of Sec.	Max Leg Dia.	Min Leg Dia.	Min Ht in (mm)	Max Ht in (mm)	Max Ht Ext. in (mm)	Retract Ht in (mm)	Folded Ht in (mm)	Weight lb (kg)	Load lb (kg)	MSRP
BSRT004XR	T-004X Red	Aluminum Alloy	4	22	13	4.9 (125)	49 (1245) *	58 (1473) *	21 (533) *	15.7 (400)	2.5 (1.13) ‡	13.2 (6)	\$199.95
BSRT004XL	T-004X Blue	Aluminum Alloy	4	22	13	4.9 (125)	49 (1245) *	58 (1475) *	21 (535) *	15.7 (400)	2.5 (1.12) ‡	13.2 (6)	\$199.95
BSRT004XK	T-004X Black	Aluminum Alloy	4	22	13	4.9 (125)	49 (1245) *	58 (1475) *	21 (535) *	15.7 (400)	2.5 (1.12) ‡	13.2 (6)	\$199.95
BSRT024X	T-024X	Carbon Fiber	4	22	13	4.9 (125)	49 (1245) *	58 (1475) *	21 (535) *	15.7 (400)	2.0 (0.92) ‡	13.2 (6)	\$350.00
BSRT005XR	T-005X Red	Aluminum Alloy	5	22	10	4.1 (104) ◇	48.0 (1240) *	54.7 (1390) *	24.2 (615) *	12.2 (310)	2.3 (1.02) ‡	8.8 (4)	\$174.95
BSRT005XL	T-005X Blue	Aluminum Alloy	5	22	10	4.1 (104) ◇	48.0 (1240) *	54.7 (1390) *	24.2 (615) *	12.2 (310)	2.3 (1.02) ‡	8.8 (4)	\$174.95
BSRT005XK	T-005X Black	Aluminum Alloy	5	22	10	4.1 (104) ◇	48.0 (1240) *	54.7 (1390) *	24.2 (615) *	12.2 (310)	2.3 (1.02) ‡	8.8 (4)	\$174.95
BSRT025X	T-025X	Carbon Fiber	5	22	10	4.1 (104) ◇	48.0 (1240) *	54.7 (1390) *	24.4 (620) *	12.2 (310)	2.0 (0.92) ‡	13.2 (6)	\$269.95

◇ - with Center Column removed * - Height including C-10 Ball Head ‡ - Weight including C-10 Ball Head



Address: 111 Asia Place, Carlstadt, NJ 07072
Phone: 201.939.7722

www.argraph.com

Twitter: @argraph



SIRUI 6-YEAR
U.S. WARRANTY ONLY
HONORED WHEN
PURCHASED FROM A U.S.
AUTHORIZED DEALER

SIRUI ET SERIES PROFESSIONAL TRIPOD KITS

The ideal combination for the
budget conscious photographer



ET
Series

ET-1004+E-10

ET-1204+E-10

ET-2004+E-20

ET-2204+E-20

If you're a photographer on a budget, but refuse to compromise on quality, the new SIRUI ET Series tripod kit is your ideal choice. Built for travel, the ET Series offers **full size tripods that fold compactly for easy storage and transport** (fits into most backpacks or carry-on luggage).

The tripod's spider - the heart of any tripod - is forged from aircraft grade aluminum alloy and the legs are available in economical aluminum or lightweight, 8-layer carbon fiber, for maximum performance, stability and long life. The matching E-10/20 Ball Head is included to provide full creative control with a **separate panning and main locking knob and useful bubble level**. Easily create panoramas with the exposed calibration scale.

Thanks to the use of Magnesium leg clamps (for added strength) and SIRUI's superior design, the flip locks provide a solid grip, enhanced stability and reliable performance.

SIRUI ET Series tripod have a uniquely designed leg mechanism that lets you to **flip the legs up 180°**. This allows the tripod to be **folded significantly smaller** than comparably sized tripods with conventional leg designs. And you can keep a ball head on the tripod and it will still fit in the compact case.

When you want to get low to the ground or shoot at unusual angles, you can invert the center column and shoot from underneath the tripod or remove the center column and replace it with the **short center column (included)**. And by adjusting the legs to any of the 3 leg angle positions, you can shoot on uneven terrain with ease.

Features:

ET Series Tripods

1. Flip leg locks for fast setup and breakdown.
2. Full-sized, but folds down small.
3. Legs fold up 180° for extra compactness.
4. The center column can be inverted for low angle shots.
5. For speed and convenience, each leg has an automatic leg angle lock mechanism.
6. Short center column is supplied for low angle or macro shooting.
7. 3 position leg angle for uneven terrain.
8. Your choice of economical Aluminum Alloy (ET-1004/ET-2004) or lightweight 8-layer 100% Carbon Fiber (ET-1204/ET-2204).
9. ET-2004/2204 have retractable spikes for outdoor photography.

Legs fold 180°
for easier travel

E Series Ball Heads

1. Separate adjustment knobs for panning and main locking for maximum control and flexibility.
2. Bubble level for fast horizontal alignment.
3. SIRUI's unique locking mechanism provides unequal locking force even with loads up to 17.6lb (8kg) for the E-10 Ball Head and 26.5lb (12kg) for the E-20 Ball Head!
4. Rugged metal locking knob offers a wear-resistant surface, solid grip.
5. Precision built to provide smooth, vibration-free movement.

Flip leg locks for easy
setup & breakdown

What's included:
Tripod, ball head,
TY-50E quick release plate, short
center column, custom
padded case, shoulder strap, tools,
instruction manual, warranty card

As seen in

 **dpreview.com**
Digital Photography Review
<http://bit.ly/ET-1204DPReview>

and **Amateur
Photographer**
<http://bit.ly/1zqTD81>

ET SERIES TRIPODS

Item #	Sirui Model #	Materials	# of Sec.	Max Leg Diam.	Min Leg Diam.	Min Ht in (mm)	Max Ht in (mm)	Max Ht Ext. in (mm)	Retract Ht in (mm)	Folded Ht in (mm)	Weight lb (kg)	Load lb (kg)	Ball Head Included	MSRP
BSRET1004	ET-1004	Aluminum Alloy	4	25	16	5.1 (130)	45.7 (1160)	55.1 (1400)*	18.9 (530)	16.5 (420)	2.9 (1.3)	17.6 (8)	E-10	\$249.95
BSRET1204	ET-1204	Carbon Fiber	4	25	16	5.1 (130)	45.7 (1160)	55.1 (1400)*	18.9 (530)	16.5 (420)	2.4 (1.1)	17.6 (8)	E-10	\$449.95
BSRET2004	ET-2004	Aluminum Alloy	4	28	19	5.3 (135)	47.8 (1215)	57.1 (1450)*	19.7 (500)	16.9 (430)	3.5 (1.6)	26.5 (12)	E-20	\$269.95
BSRET2204	ET-2204	Carbon Fiber	4	28	19	5.3 (135)	47.8 (1215)	57.1 (1450)*	19.7 (500)	16.9 (430)	2.9 (1.3)	26.5 (12)	E-20	\$499.95

* includes short center column and E Series Ball Head

ARGRAPH
CORP.

www.argraph.com

Address: 111 Asia Place, Carlstadt, NJ 07072
Phone: 201.939.7722

Twitter: @argraph



SIRUI 6-YEAR
U.S. WARRANTY ONLY
HONORED WHEN
PURCHASED FROM A U.S.
AUTHORIZED DEALER

SIRUI 3T-35 PROFESSIONAL TRIPOD KITS

Never Be Without a Tripod Again



3T-35

Never be without a tripod again. A nice idea, but no one has been able to build a high quality tripod that can really say that. Until today.

The **SIRUI 3T-35** is an ultra-compact, rugged, portable and flexible table top tripod...and much more! It can easily fit in a camera bag, backpack or back pocket. And the belt hook keeps it ready at any time! It's made of forged aircraft grade aluminum alloy, so it's rugged and built to last!

Its **large, stable support legs** can hold digital and video cameras **weighing up to 8.8 lb (4 kg)**. And the two-section center column can **extend to 13.5 in (34.4cm)**!

When you can't see over the crowd, fold down the support legs for added reach. And if you need to do a self-portrait, it couldn't be easier. The **legs fold up for storage** and provide an excellent grip for shooting photos or videos.

The excellent ball head comes with a quick release plate and, when you remove the center column, can be placed directly onto the support legs for low angle shooting and maximum stability. And you can lean against a tree or put it on a ledge for unique perspectives.



Ultra-compact, portable and flexible table-top tripod



Only 9 in
(22.9cm)
when folded



Arca-compatible
Quick Release Plate

2 section
center column
for added
height - up to
13.5 in



3T-35K Black

3T-35R Red

High Performance
Ball Head



Features:

1. Ultra-compact, portable and flexible table top tripod.
2. Two-section center column for added height - up to 13.5 in (34.4cm) tall.
3. Large legs provide excellent stability and fold down for added reach.
4. Legs fold up for storage, plus offer a secure hold when shooting videos or stills.
5. Includes a high performance ball head with Arca-compatible Quick Release plate.
6. Remove the center column and the ball head fits directly onto the legs for low angle shooting and maximum stability.

3T-35 TABLETOP TRIPOD KIT

Item #	Sirui Model #	Materials	# of Sec.	Max Leg Diam.	Min Leg Diam.	Min Ht in (mm)	Max Ht in (mm)	Max Ht Ext. in (mm)	Folded Ht in (mm)	Weight lb (kg)	Load lb (kg)	MSRP
BSR3T35K	3T-35K (Black)	Aluminum Alloy	2	16	13	4.5 (114) *	10.2 (257)	13.5 (341)	9.5 (242)	0.9 (0.43)	8.8 (4)	\$109.95
BSR3T35R	3T-35R (Red)	Aluminum Alloy	2	16	13	4.5 (114) *	10.2 (257)	13.5 (341)	9.5 (242)	0.9 (0.43)	8.8 (4)	\$109.95

* Height with head



ARGRAPH
CORP

www.argraph.com

Address: 111 Asia Place, Carlstadt, NJ 07072
Phone: 201.939.7722

Twitter: @argraph



SIRUI 6-YEAR
U.S. WARRANTY ONLY
HONORED WHEN
PURCHASED FROM A U.S.
AUTHORIZED DEALER

NEW! SIRUI T-X SERIES PROFESSIONAL TRIPOD KITS

Our most compact, full-sized tripod kits specifically designed with the traveler in mind.



There are many times when people are traveling or just shooting in the neighborhood that they want a full sized tripod that is a bit sturdier and taller than our famous T-005X tripods to use with longer lenses and to shoot on a windy day. Yet, they still want it to fold up small and lightweight so they can easily carry it in a back pack or carry-on luggage.

Sirui and Argraph have teamed up to do just that with two new series of tripod kits - The T-P and -T-XL each series offers two tripod and head combos to make it easy to choose the right product at special combo pricing.

The TP series consists of our best-selling T-1005X packaged with an E-10 head and the sturdier T-2005X packed with the E-20 head. Both are less than 15" when folded for ease of carrying yet will handle 17.6 lbs or 26.5 lbs load respectively and have a 6 year warranty.

For those who need a taller tripod there is the New T-XL series which fold to 18" and extend to almost 6 feet. These also include the E-10 and E-20 head respectively and have a carrying case and 6 year warranty.

These new kits make the perfect companions for people shooting sports, nature, bird watching or traveling. They are great for soccer moms and dads, students, and weekend warriors.

Sirui folds small, stands tall and holds more weight for its size than the competition.

Features

1. The ideal tripod for travelers - full-sized, but folds down small
2. Legs fold up 180° for extra compactness
3. The center column can be inverted for angle shots
4. For speed and convenience, each leg has an automatic leg angle lock mechanism
5. Short center column is supplied for low angle or macro shooting.
6. Three position leg angle for uneven terrain.
7. Made from Aircraft Grade Aluminum Alloy
8. T-X 2 Series has retractable spikes for outdoor photography.
9. Short center column can be screwed into standard center column for increased height.

T-P SERIES TRIPOD KITS

Item #	Sirui Model #	Materials	# of Leg Sec.	Max Leg Dia.	Min Leg Dia.	Min Ht in (mm)	Max Ht in (mm)	Max Ht Ext. in (mm)	Retract Ht in (mm)	Folded Ht in (mm)	Weight lb (kg)	Load lb (kg)	Ball Head Included	MSRP
NEW! BSRT1005P	T-1005P	Aluminum Alloy	5	25	13	8.4 (215)	47.6 (1210)	57.9 (1471)*	19.4 (495)	13.8 (350)	3.8 (1.7)	17.6 (8)	E-10	\$249.95
NEW! BSRT2005P	T-2005P	Aluminum Alloy	5	28	16	9.0 (230)	52.7 (1340)	63.8 (1621)*	21.6 (550)	14.9 (380)	4.9 (2.3)	26.5 (12)	E-20	\$269.95

T-L SERIES TRIPOD KITS

NEW! BSRT1004L	T-1004XL	Aluminum Alloy	4	25	16	5.5 (140)	52 (1320)	69.7 (1770)*	24.4 (620)	18.3 (465)	2.9 (1.3)	17.6 (8)	E-10	\$259.95
NEW! BSRT2004L	T-2004XL	Aluminum Alloy	4	28	19	5.7 (145)	53.5 (1360)	71.1 (1806)*	25.2 (640)	18.5 (540)	3.7 (1.7)	26.5 (12)	E-20	\$299.95

* - with both center columns and ball head



T-X Series

T-X Tripods +
E-Ball Heads.
The Most
Compact,
Full-Size
Travel Kits

E-Series Ball Head



T-1005P

Includes E-10 Ball Head

T-2005P

Includes E-20 Ball Head

T-1004XL

Includes E-10 Ball Head

T-2004XL

Includes E-20 Ball Head

What's included:
E-Series Ball Head,
Short center column,
custom case, padded strap,
tools, instruction manual,
warranty card

E Series Ball Heads

1. Separate adjustment knobs for panning and main locking for maximum control and flexibility.
2. Bubble level for fast horizontal alignment.
3. SIRUI's unique locking mechanism provides unequalled locking force even with loads up to 17.6lb (8kg) for the E-10 Ball Head and 26.5lb (12kg) for the E-20 Ball Head!
4. Rugged metal locking knob offers a wear-resistant surface, solid grip.
5. Precision built to provide smooth, vibration-free movement.
6. E-10/E-20 Ball Heads come equipped with Sirui Arca compatible TY-50E Quick Release Plates.



www.argraph.com

Address: 111 Asia Place, Carlstadt, NJ 07072
Phone: 201.939.7722

Twitter:@argraph



SIRUI 6-YEAR
U.S. WARRANTY ONLY
HONORED WHEN
PURCHASED FROM A U.S.
AUTHORIZED DEALER

SIRUI T-X SERIES PROFESSIONAL TRIPODS

Our most compact, full-sized tripods
specifically designed with the
traveler in mind.

Winner of Germany's
Foto Magazin Tripod
Quality Test - M3204

Winner of Camera Magazine
Innovative Imaging Product
of the Year - TX Series

5 of the Top 10 Ball Heads
in Germany's 'Traumflieger
Test of 33 Ball Heads'
are Sirui Ball Heads



T-X Series

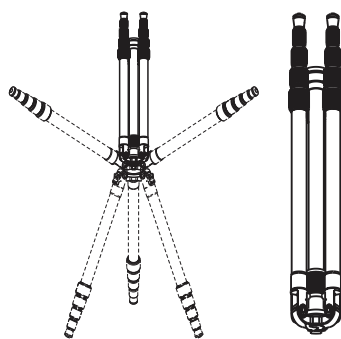

Legs fold up 180° for
extra compactness



TX series tripods - our most compact full-size tripods - specifically designed with the traveler in mind.

For easy storage and transport, the tripod can fold as small as 13.8 in (35cm) - about the size of a 2L water bottle - and weighs as little as 2.0 lb (0.9kg) !!

You can easily fit a TX tripod into a backpack, camera bag or carry-on luggage!

The TX Series tripods have a unique leg mechanism that allows you to fold the legs up 180°. This allows the tripod to be folded significantly smaller than comparably sized tripods with conventional leg designs.

Simply depress the leg angle lock and invert the legs 180°. An added advantage is that you can keep a ball head on the tripod and it will still fit in the compact carrying case that's included.

T-1005X

Recommended Ball Heads:
K-10X, G-10X

T-1205X

Recommended Ball Heads:
K-10X, G-10X

T-2005X

Recommended Ball Heads:
K-20X, G-20X

T-2205X

Recommended Ball Heads:
K-20X, G-20X

Features

1. The ideal tripod for travelers - full-sized, but folds down small
2. Legs fold up 180° for extra compactness
3. The center column can be inverted for angle shots
4. For speed and convenience, each leg has an automatic leg angle lock mechanism
5. Short center column is supplied for low angle or macro shooting.
6. Three position leg angle for uneven terrain.
7. Your choice of economical aluminum or ultra lightweight carbon fiber.
8. TX 2 Series has retractable spikes for outdoor photography.
9. Short center column can be screwed into standard center column for increased height.

What's included:

Short center column,
custom case, padded strap,
tools, instruction manual,
warranty card

T-X SERIES TRIPODS

Item #	Sirui Model #	Materials	# of Sec.	Max Leg Diam.	Min Leg Diam.	Min Ht in (mm)	Max Ht in (mm)	Max Ht Ext. in (mm)	Retract Ht in (mm)	Folded Ht in (mm)	Weight lb (kg)	Load lb (kg)	MSRP
BSRT1005	T-1005X	Aluminum Alloy	5	25	13	4.9 (125)	44.1 (1100)	55.4 (1407)*	15.9 (405)	13.8 (350)	2.4 (1.1)	22 (10)	\$154.95
BSRT1205	T-1205X	Carbon Fiber	5	25	13	4.9 (125)	44.1 (1100)	55.4 (1407)*	15.9 (405)	13.8 (350)	2.0 (0.9)	22 (10)	\$374.95
BSRT2005	T-2005X	Aluminum Alloy	5	28	16	5.1 (130)	48.8 (1240)	60.9 (1566)*	17.7 (450)	15 (380)	3.3 (1.5)	26.5 (12)	\$199.95
BSRT2205	T-2205X	Carbon Fiber	5	28	16	5.1 (130)	48.8 (1240)	60.9 (1566)*	17.7 (450)	15 (380)	2.6 (1.2)	26.5 (12)	\$414.95

* - with both center columns



www.argraph.com

Address: 111 Asia Place, Carlstadt, NJ 07072
Phone: 201.939.7722

Twitter: @argraph



SIRUI 6-YEAR U.S. WARRANTY ONLY HONORED WHEN PURCHASED FROM A U.S. AUTHORIZED DEALER

SIRUI EN SERIES PROFESSIONAL TRIPODS



EN Series

Full-sized Tripod with Flip Leg Locks and Monopod Leg

SIRUI Introduces a New Series of Flip Lock Tripods

When you need a full-featured tripod that's designed to be used under a wide range of shooting situations, look no further than the SIRUI EN Series tripods. Based on the impressive features of the SIRUI N-X series - one of SIRUI's most successful models - SIRUI EN series tripods incorporate **SIRUI's new advanced Flip Leg Lock System that makes setup and breakdown fast and easy.** Simply flip open the leg locks and the legs smoothly slide open. Thanks to the use of Magnesium leg clamps (for added strength) and SIRUI's superior design, the flip locks provide a solid grip, enhanced stability and reliable performance.

SIRUI EN Series tripods have a unique leg mechanism that lets you to **flip the legs up 180°**. This allows the tripod to be folded significantly smaller than comparably sized tripods with conventional leg designs. And you can keep a ball head on the tripod and it will still fit in the compact case.

The **split center column** makes changing from the standard center column to the short center column fast and easy. By unscrewing the hanging hook from the bottom of the center column, the column separates and the short center column remains on the tripod, ready to take macro or low angle shots. Or, you can invert the center column and shoot from underneath the tripod. And with 3 leg angle positions, you can shoot on uneven terrain with ease.

For added versatility, **one of the tripod legs can be converted into a monopod!** Extremely convenient when tripods are not allowed or when you're shooting in tight spaces. And by attaching the larger section of the split center column onto the monopod leg, you can significantly increase the height of the monopod.

Features:

EN Series Tripods

1. Tripod leg converts to monopod. Center column can be attached for increased height
2. Tripod leg converts to monopod. Center column can be attached for increased height
3. The center column can be inverted for unusual low angle shots
4. For speed and convenience, each leg has an automatic leg angle lock mechanism
5. Short center column allows low angle or macro shooting
6. Three leg angle positions for uneven terrain
7. Retractable spikes for outdoor photography
8. Ball head can remain on the tripod and still fit in the case
9. Legs fold up 180° for extra compactness
10. Your choice of economical Aluminum Alloy (EN-2004) or ultra lightweight 100% Carbon Fiber (EN-2204)



EN-2004
Recommended Ball Heads:
K-20X, G-20X

EN-2204
Recommended Ball Heads:
K-20X, G-20X

Legs fold up 180° for extra compactness

Flip Leg Locks for easy setup & breakdown

What's included:
Tripod, split-center column, custom padded case, shoulder strap, tools, spring loaded hook, monopod kit (wrist strap, extra 1/4 ~ 3/8 tripod screw), instruction manual, warranty card.

Converts to a monopod

EN SERIES TRIPODS

Item #	Sirui Model #	Materials	# of Leg	Max Leg Sec. Diam.	Min Leg Diam.	Min Ht in (mm)	Max Ht in (mm)	Max Ht Ext. in (mm)	Retract Ht in (mm)	Folded Ht in (mm)	Mono Max Ht in (mm)	Mono Min Ht in (mm)	Weight lb (kg)	Load lb (kg)	MSRP
BSREN2004	EN-2004	Aluminum Alloy	4	28	19	5.7 (145)	53.1 (1350)	64.6 (1640) *	21.5 (545)	18.9 (480)	63.6 (1615)	17.5 (445)	22 (10)	30.9 (14)	\$249.95
BSREN2204	EN-2204	Carbon Fiber	4	28	19	5.7 (145)	53.1 (1350)	64.6 (1640) *	21.5 (545)	18.9 (480)	63.6 (1615)	17.5 (445)	22 (10)	30.9 (14)	\$549.95

* With center column attached



www.argraph.com

Address: 111 Asia Place, Carlstadt, NJ 07072
Phone: 201.939.7722

Twitter: @argraph



**SIRUI 6-YEAR
U.S. WARRANTY ONLY
HONORED WHEN
PURCHASED FROM A U.S.
AUTHORIZED DEALER**

SIRUI N-X SERIES PROFESSIONAL TRIPODS



N-X Series

The perfect blend of height, load capacity and flexibility



The NX Series tripod is an excellent all-purpose model with many useful features not found in other tripod systems. By using high quality materials and designing the leg tubes to have only a 3mm difference in diameter for added stability, the tall N-2204X is also able to be folded very compactly! It can extend to an impressive 64 in (162.5cm), while folding down to only 18.5 in. (47cm)! Yet, it weighs only 3.3 lbs (1.5kg) and has a load rating of 33 lbs (15kg).

The NX Series tripod has a unique leg mechanism that allows you to move the legs up 180°. This allows the tripod to be folded significantly smaller than comparably sized tripods with conventional leg designs. Simply depress the leg angle lock and invert the legs 180°. An added advantage is that you can keep a ball head on the tripod and it will still fit in the included tripod case. Another advantage is that the N-series can be converted into a monopod.

The new split center column makes changing from the standard center column to the short center column fast and easy. By unscrewing the hanging hook from the bottom of the center column, the column separates and the short center column remains on the tripod, ready to go! No need to remove the full-sized center column and replace it with the short center column. In addition to being a high quality tripod, N Series tripods have the ability to be converted into a monopod! This is really convenient when tripods are not allowed or when you're shooting in tight spaces. By attaching the larger portion of the split center column to the N-X series you can increase the height of the monopod.

N-1004KX

Recommended Ball Heads:
K-10X, G-10X

N-1204X

Recommended Ball Heads:
K-10X, G-10X

N-1205X

Recommended Ball Heads:
K-20X, G-20X

N-2004KX

Recommended Ball Heads:
K-20X, G-20X

N-2204X

Recommended Ball Heads:
K-20X, G-20X

N-3004X

Recommended Ball Heads:
K-20X, G-20X

N-3204X

Recommended Ball Heads:
K-20X, G-20X

Features

1. Tripod converts to monopod; center column can be attached for even more height.
2. Legs fold up 180° for extra compactness
3. The center column can be inverted for unusual low angle shots
4. For speed and convenience, each leg has an automatic leg angle lock mechanism
5. Short section of split center column allows for low angle or macro shooting
6. Three position leg angle for uneven terrain
7. Your choice of economical aluminum or lightweight carbon fiber
8. N2 Series has retractable spiked feet for outdoor photography



Legs splay out for low-angle shooting

What's included:

Custom padded case, shoulder strap, extra reversible screw, mounting platform, spring-loaded hook, split center column, tools, manual, warranty card

N-X SERIES TRIPODS

Item #	Sirui Model #	Materials	# of Sec.	Max Leg Diam.	Min Leg Diam.	Min Ht in (mm)	Max Ht in (mm)	Max Ht Ext. in (mm)	Retract Ht in (mm)	Folded Ht in (mm)	Mono * Max Ht in (mm)	Mono Min Ht in (mm)	Weight lb (kg)	Load lb (kg)	MSRP
BSRN1004K	N-1004KX	Aluminum Alloy	4	25	16	5.5 (140)	52 (1320)	63 (1600)	20.9 (531)	18.3 (465)	61.6 (1565)	16.9 (430)	3.1 (1.4)	26.5 (12)	\$219.95
BSRN1204X	N-1204X	Carbon Fiber	4	25	16	5.5 (140)	52 (1320)	63 (1600)	20.8 (530)	18.3 (465)	61.6 (1565)	16.9 (430)	2.4 (1.1)	26.5 (12)	\$499.95
BSRN1205X	N-1205X	Carbon Fiber	5	25	13	5.3 (135)	52.2 (1325)	60.6 (1540)	18.9 (480)	16.7 (425)	59.2 (1505)	14.9 (380)	2.4 (1.1)	22.0 (10)	\$509.95
BSRN2004K	N-2004KX	Aluminum Alloy	4	28	19	5.7 (145)	53.5 (1360)	64 (1625)	21.3 (540)	18.5 (470)	63 (1600)	16.9 (430)	4.0 (1.8)	33.1 (15)	\$249.95
BSRN2204X	N-2204X	Carbon Fiber	4	28	19	5.7 (145)	53.5 (1360)	64 (1625)	21.3 (540)	18.5 (470)	63 (1600)	16.9 (430)	3.3 (1.5)	33.1 (15)	\$549.95
BSRN3004X	N-3004X	Aluminum Alloy	4	32	22	5.9 (150)	57.9 (1470)	69.3 (1760)	22.8 (580)	20.1 (510)	68.9 (1750)	18.5 (470)	5.1 (2.3)	39.7 (18)	\$299.95
BSRN3204X	N-3204X	Carbon Fiber	4	32	22	5.9 (150)	57.9 (1470)	69.3 (1760)	22.8 (580)	20.1 (510)	68.9 (1750)	18.9 (480)	4.2 (1.9)	39.7 (18)	\$599.95

* includes height of center column



www.argraph.com

Address: 111 Asia Place, Carlstadt, NJ 07072
Phone: 201.939.7722

Twitter: @argraph



**SIRUI 6-YEAR
U.S. WARRANTY ONLY
HONORED WHEN
PURCHASED FROM A U.S.
AUTHORIZED DEALER**

NEW! SIRUI W SERIES WATERPROOF PROFESSIONAL TRIPODS



**W
Series**

Our first waterproof tripod specifically designed to brave the elements!

SIRUI W Series Waterproof tripods expand the capabilities of outdoor photographers and videographers like no other tripod. While most tripods warn against use in or near water and sand, the W Series welcomes it!

The SIRUI designed WPS Waterproof Sealing System has a series of waterproof rings that prevent water from seeping into the tripod leg tubes and locks and causing damage.

The SIRUI designed waterproof leg locks incorporate waterproof and leak-proof materials used in the automotive industry. The rubber locking components firmly grasp the legs without any gap when they are tightly locked - preventing water, dust or small particles from entering the legs or the locking system. This waterproof (not just water resistant) system lets you safely shoot in extreme environmental conditions (also ideal for use with spotting scopes and binoculars).

Equally impressive is SIRUI's ability to extend and contract the legs as smoothly as their standard models. And with 1/2 twist leg locks, setup and break down is fast and easy.

Using the highest quality materials and precisely manufactured leg tubes lets SIRUI achieve uncompromising stability. The SIRUI W-2204 extends up to an impressive 70.9 in. (1800 mm) - vital when shooting in deeper water or to keep your equipment away from splashes and salt spray - while folding down to only 20.5 in. (520 mm). It weighs just 3.7 lb (1.7 kg.), but holds up to 39.7 lb. (18 kg).

The redesigned Leg Angle Locks make adjustments faster and easier than ever before. Push the lock and it stays open until you select the desired position. Extremely convenient with wet or gloved hands! The slip-resistant rubber feet can be replaced with stainless steel spikes (included) for added grip and stability.

The SIRUI W Series tripod's unique leg mechanism lets you invert the legs 180° - for compact storage and easy transport. And the split center column makes changing from standard center column to short center column fast and easy.

One of the legs can be converted into a waterproof monopod! Ideal when a tripod is not allowed or when you're shooting in tight spaces. Attach the center column to increase the height of the monopod.

SIRUI W Series Waterproof tripods are available in economical Aluminum Alloy or Lightweight 10-Layer 100% Carbon Fiber.

1. Waterproof leg design - SIRUI designed waterproof ring system prevents water from seeping into the tripod legs and causing damage. Not just water resistant - actually waterproof!!
2. Lightweight 10 layer 100% Carbon Fiber for added strength, increased load capacity and vibration reduction (except Aluminum Alloy W-1004, W-2004).
3. Ergonomic Leg Angle Locks make adjustments fast and easy. Extremely convenient with wet or gloved hands!
4. For speed and convenience, each leg has an automatic leg angle lock mechanism.
5. Tripod leg converts into waterproof monopod. Center column can be attached for increased height.
6. The center column can be detached and inverted for low angle or macro shooting.
7. Legs fold up 180° for extra compactness.
8. Three leg angle positions for uneven terrain.
9. Bubble level for fast horizontal alignment
10. Slip-resistant rubber feet can be replaced with stainless steel spikes (included).
11. Hook on bottom of the center column can hold a weight bag for added stability.



- W-1004**
Recommended Ball Heads:
K-10X, G-10X
- W-1204**
Recommended Ball Heads:
K-10X, G-10X
- W-2004**
Recommended Ball Heads:
K-20X, G-20X
- W-2204**
Recommended Ball Heads:
K-20X, G-20X



What's included:
Tripod, split-center column, custom padded case, shoulder strap, tools, spring loaded hook, metal spikes, monopod kit (wrist strap, extra 1/2 ~ 3/8 tripod screw, extra platform), instruction manual, warranty card

W SERIES TRIPOD KITS

Item #	Sirui Model #	Materials	# of Leg Sec.	Leg Dia.	Leg Min Dia. in (mm)	Min Ht in (mm)	Max Ht in (mm)	Max Ht Ext.	Fold Ht in (mm)	Retract Ht in (mm)	Mono Max Ht	Mono Min Ht.	Weight lb (kg)	Load lb (kg)	MSRP	
NEW!	BSRW1004	W-1004	Aluminum Alloy	4	25.8	15	5.7 (145)	53.5 (1360)	65 (1650)	19.3 (490)	20.9 (530)	63.8 (1800)	17.3 (440)	3.7 (1.7)	33.1 (15)	\$300.00
NEW!	BSRW1204	W-1204	Carbon Fiber	4	25.8	15	5.7 (145)	53.5 (1360)	65 (1650)	19.3 (490)	20.9 (530)	63.8 (1800)	17.3 (440)	3.1 (1.4)	33.1 (15)	\$600.00
NEW!	BSRW2004	W-2004	Aluminum Alloy	4	29.4	18.6	6.1 (155)	57.9 (1470)	70.9 (1800)	20.5 (520)	22 (560)	69.7 (1770)	18.5 (470)	4.6 (2.1)	39.7 (18)	\$325.00
NEW!	BSRW2204	W-2204	Carbon Fiber	4	29.4	18.6	6.1 (155)	57.9 (1470)	70.9 (1800)	20.5 (520)	22 (560)	69.7 (1770)	18.5 (470)	3.7 (1.7)	39.7 (18)	\$650.00



Address: 111 Asia Place, Carlstadt, NJ 07072
Phone: 201.939.7722



SIRUI 6-YEAR U.S. WARRANTY ONLY HONORED WHEN PURCHASED FROM A U.S. AUTHORIZED DEALER

SIRUI R-X SERIES PROFESSIONAL PHOTO/VIDEO TRIPODS



R-X Series

**Tall, Strong, Flexible
2 Tripods in 1**

The **RX4 and RX5 series**, SIRUI's largest tripods are now taller, stronger and more stable than ever before! The redesigned spider provides increased stability and load capacity. New cross pattern of Carbon Fiber layers provides significantly increased stability and vibration reduction.

The new leg angle locking system makes selecting one of the three angle positions fast and reliable while the three point locking platform makes converting from a still to video tripod fast and secure (the locking channel on the platform/75mm bowl adds stability and greater locking integrity).

For speed and convenience, each leg has an automatic leg angle lock mechanism. The flat platform can be replaced with a 75mm bowl for use with SIRUI video heads. Built-in bubble level makes horizontal adjustments fast and easy. Replaceable rubber foot/stainless steel spike. For convenience the hanging hook is also an allen key tool.

Features

1. Redesigned spider provides increased stability and load capacity.
2. New cross pattern of Carbon Fiber layers provides significantly increased stability and vibration reduction.
3. New leg angle locking system makes selecting one of the three angle positions fast and reliable.
4. Three point locking platform makes converting from a still to video tripod fast and secure (the locking channel on the platform/75mm bowl adds stability and greater locking integrity).
5. For speed and convenience, each leg has an automatic leg angle lock mechanism.
6. Lightweight 10 layers 100% Carbon Fiber legs.
7. Flat platform can be replaced with a 75mm bowl for use with SIRUI video heads.
8. Built-in bubble level makes horizontal adjustments fast and easy.
9. Replaceable rubber foot/stainless steel spike.
10. Hanging hook is also an allen key tool.



Top plate is removable for placement of included 75mm bowl

Optional RX-75A 75mm Adapter Bowl

Optional RX-75B 75mm Leveling Ball Set for video applications

What's included:
75mm adapter bowl, Custom case, padded shoulder strap, tools, stainless steel spikes, instruction manual



New leg angle locking system makes selecting one of the three angle positions fast and reliable



Pull Out Leg Locking System Provides Easier Positioning

Watch the RX Video
WATCH VIDEO <http://bit.ly/SiruiR-X>

R-X SERIES TRIPODS

Item #	Sirui Model #	Materials	# of Sec.	Max Leg Diam	Min Leg Diam	Min Ht in (mm)	Max Ht in (mm)	Retract Ht in (mm)	Weight lb (kg)	Load lb (kg)	MSRP
BSRR4213X	R-4213X	Carbon Fiber	3	36	28	4.1 (105)	59.1 (1500)	26 (660)	4.9 (2.2)	55.1 (25)	\$870.95
BSRR4214X	R-4214X	Carbon Fiber	4	36	24	3.5 (90)	59.1 (1500)	21.7 (550)	4.9 (2.2)	55.1 (25)	\$1004.95
BSRR5214X	R-5214X	Carbon Fiber	4	40	28	3.5 (90)	63 (1600)	22.8 (580)	5.5 (2.5)	66.1 (30)	\$1071.95
BSRR5214L	R-5214XL	Carbon Fiber	4	40	28	3.9 (100)	78.7 (2000)	27.2 (690)	6.2 (2.8)	66.1 (30)	\$1171.95

Item #	Sirui Model #	Description	Dimensions	Weight lb (kg)	Load lb (kg)	MSRP
NEW BSRRX75A	RX-75A	75mm Adapter Bowl	Dia: 3.3 (85) Height: 1.5 (38)	0.3 (0.14)	39.7 (18)	\$ 50.00
NEW BSRRX75B	RX-75B	75mm Leveling Ball Set	Dia: 3.6 (92) Height: 8.1 (205)	0.9 (0.4)	39.7 (18)	\$100.00
BSRY75A	Y-75A	75mm Adapter Bowl	Dia: 3.6 (91) Height: 2.9 (1.1)	0.2 (0.1)	39.7 (18)	\$ 46.95
BSRY75B	Y-75B	75mm Leveling Ball Set	Dia: 3.6 (92) Height: 7.3125 (186)	0.9 (0.4)	39.7 (18)	\$ 89.95



www.argraph.com

Address: 111 Asia Place, Carlstadt, NJ 07072
Phone: 201.939.7722

Twitter: @argraph



SIRUI 6-YEAR
U.S. WARRANTY ONLY
HONORED WHEN
PURCHASED FROM A U.S.
AUTHORIZED DEALER

SIRUI R SERIES PROFESSIONAL TRIPODS

Cross-platform tripods for big cameras, long lenses and professional video equipment.



R
Series

R-3203

R-4203L

The **R3 and R4 series** are uniquely designed to satisfy many needs. They can be used for still photography - with big cameras and large lenses - plus, by changing the mounting plate, they can be converted into high quality tripods for video cameras and DSLRs with digital video capabilities.

Perfect for still and video camera systems

R3, R4 Series tripods have a unique mounting platform that can accept a wide range of mounting plates, bowl adapters, leveling devices, etc. for use with professional film and digital SLR and video cameras. This approach lets you quickly exchange plates with different cameras or heads (ball head, gimbal, etc.) already attached.

The center column-free design allows you to get as close as 3.5 inches (9cm) to the ground for low angle or macro shots!

Built for heavy equipment

The R3/R4 series is especially well suited for use with large, heavy telephoto lenses - for photographing birds and other forms of wildlife.

It is also an excellent choice when shooting with high quality, professional video equipment.

Total Flexibility

R3/R4 Series tripods offer outstanding flexibility. You can use these tripods for DSLR, medium and large format and video cameras. The flat mounting plate can be easily exchanged with a wide range of adapters for various shooting applications.

R3/R4 Series tripods have the largest diameter leg tubes in the SIRUI lineup. With a maximum diameter of 36mm, they have a maximum load capacity of 44 lb. (20kg) - ideal for heavy cameras and telephoto lenses!

Features

1. Unique design of R3/R4 allows you to change mounting plates for different applications
2. Built-in bubble level helps make horizontal adjustments fast and easy
3. For speed and convenience, each leg has an automatic leg angle lock mechanism
4. 2 position leg angle for uneven terrain
5. Retractable spiked feet for outdoor photography



Optional
75mm Bowl Y75A &
75mm Leveling Head Y75B
for video applications
can be seen at our
website at:
[http://www.argraph.com/
Sirui-VH-Series-Fluid-Heads.
html#vhAccessories](http://www.argraph.com/Sirui-VH-Series-Fluid-Heads.html#vhAccessories)

What's included:
Custom case, padded
shoulder strap, tools,
instruction manual,
warranty card

R SERIES TRIPODS

Item #	Sirui Model #	Materials	# of Sect.	Max Leg Diam	Min Leg Diam	Min Ht in (mm)	Max Ht in (mm)	Retract Ht in (mm)	Weight lb (kg)	Load lb (kg)	MSRP
BSRR3203	R-3203	Carbon Fiber	3	32	25	4.3 (110)	60.2 (1530)	26.2 (660)	4.4 (2.0)	37.4 (17)	\$639.95
BSRR4203	R-4203	Carbon Fiber	3	36	28	4.1 (105)	59.8 (1520)	26.6 (675)	4.8 (2.2)	44 (20)	\$746.95
BSRY75A	Y-75A	75mm Adapter Bowl				Dia: 3.6 (91)	Height: 2.9 (1.1)		0.2 (0.1)	39.7 (18)	\$ 46.95
BSRY75B	Y-75B	75mm Leveling Ball Set				Dia: 3.6 (92)	Height: 7.3125 (186)		0.9 (0.4)	39.7 (18)	\$ 89.95



www.argraph.com

Address: 111 Asia Place, Carlstadt, NJ 07072
Phone: 201.939.7722

Twitter: @argraph



SIRUI 6-YEAR
U.S. WARRANTY ONLY
HONORED WHEN
PURCHASED FROM A U.S.
AUTHORIZED DEALER

SIRUI PH-20 PROFESSIONAL GIMBAL HEAD



PH-20

The World's First Ultra-Strong Carbon Fiber Gimbal Head

PH-20

PH-20 GIMBAL HEAD



Why a Gimbal Head

When using a long telephoto or zoom lens, it can be almost impossible to hand hold your equipment and frame images. To insure your images are sharp, you need a sturdy tripod. If you use a 3 way-head or ball head on the tripod it is extremely difficult to react quickly and follow moving objects. You need to adjust the tension of the ball or unlock the 3-way head. By then the moment is lost.

Only a Gimbal Head will do!

The Sirui PH-20 Gimbal Head makes your heavy camera and lens system fast-handling and weightless! Attach the lens to the PH-20 and you can smoothly and precisely track fast moving subjects, pre-set your composition or be ready for unexpected photo opportunities.

Superior design, materials and construction

By using **cross-pattered, multi-layer carbon fiber** in the arm and **forged aircraft aluminum** for the L-bracket, the PH-20 is very strong - holds up to 44lb/20kg! – and extremely light - only 2.4lb/1.09kg! Plus, carbon fiber offers reduced vibrations and better tolerance to temperature changes. With the camera and lens perfectly balanced on the gimbal head, there's no need to lock any controls. You can quickly and easily move your camera in any direction with only the slightest amount of force. In fact, a correctly aligned system can be controlled with one finger! Add a Sirui M or R3/R4 series Tripod and you have a strong, sturdy, lightweight, easy to carry platform to hold your camera and long lens for those sharp pictures you demand.

When and why?

Photographing wild birds or animals, shooting sports, tracking racing boats, airplanes, cyclists or runners, or anything that walks, runs or flies, nothing can improve your results like a Sirui PH-20 Gimbal Head!

And for added flexibility and convenience, the PH-20 can be converted from a L-bracket unit to a simpler side mount system with the included quick release platform and tools.



Sirui Innovations

Not all Gimbal heads are created equal. The exciting new Sirui Professional PH-20 Gimbal Head has many innovations that make it an outstanding choice. From its lightweight but rugged carbon fiber arm, to its Arca-compatible quick release system, calibrated quick release platform and included quick release plate, the Sirui PH-20 is designed with the photographer in mind.

Features

- High strength, low weight carbon fiber for the curved arm and forged aircraft aluminum for the L-platform.
- Makes your camera/lens outfit "weightless" and will smoothly move horizontally 360° and tilt +150° to -60° (and stay in position without locking the head!), with a slight touch.

What's included:

Custom fitted case, Quick release plate, Quick release platform, tools, instruction manual, warranty card



PH-120
Quick Release Plate



PH-20 GIMBAL HEAD

Item #	Sirui Model #	Materials	Dimensions in (mm)	Weight lb (kg)	Load lb (kg)	MSRP
BSRPH20	PH-20	Carbon Fiber	9.1 (230) x 4.7 (120) x 9.1 (230)	2.9 (1.3)	44.1 (20)	\$665.95

PH-120 Quick Release Plate

Item #	Sirui Model #	Materials	Dimensions in (mm)	Weight oz (g)	MSRP
BSRPH120	PH-120	Aluminum Alloy	4.72 (120) x 1.53 (39) x 0.425 (10.8)	0.172 (0.78)	\$ 59.95



www.argraph.com

Address: 111 Asia Place, Carlstadt, NJ 07072
Phone: 201.939.7722

Twitter: @argraph



SIRUI 6-YEAR U.S. WARRANTY ONLY HONORED WHEN PURCHASED FROM A U.S. AUTHORIZED DEALER

SIRUI P-S MULTI-FUNCTION PHOTO/VIDEO MONOPODS

WHERE SUPPORT MEETS FLEXIBILITY

Photo Monopod, Video Monopod and Table-Top Tripod All In One Compact System



P-S Series

SIRUI's revolutionary New P-S Series Multi-Function Photo/Video Monopods have three sturdy fold-down support feet that provide stability and flexibility not possible with conventional monopods! The rugged feet allow you to pan the monopod 360° and tilt 20° in any direction without worrying that the monopod will move out of position. And you can step on the feet for even greater stability!

The SIRUI designed and patented 360° panning hand grip produces smooth, pro-level panning effects. It's foam padded for a comfortable feel and secure hold in cold or wet weather conditions. If you don't need the panning function, simply tighten the locking collar.

To tilt the monopod 20° in any direction, SIRUI utilizes a precision ball head mechanism in the base of the monopod. You can control the amount of drag that you need by turning the tension control knob. To lock the monopod in a vertical position, simply screw down the vertical locking collar and it will stand upright on its support feet*. The support feet can fold flush and lock into position against the monopod leg.

If you don't need the feet, you can easily unscrew them and convert the SIRUI P-S Photo/Video Monopod into a conventional monopod. When the feet are removed a large rubber foot lets you work on slippery surfaces and can be replaced with the included stainless steel spike for use outdoors. And for added flexibility, the feet can be used as a table-top or low angle tripod.

SIRUI P-S Series Photo/Video Monopods are equally at home with photo and video equipment. And if you need to get your equipment up high or want an unusual perspective, you can, thanks to the lightweight design! For video or still photography you can add the SIRUI VA-5 and VH-10 Video Heads, L-10 or any SIRUI BALL Head. For fast connect/disconnect, you can add the SIRUI MP-20 Photo or VH-90 Video Quick Release Platforms.

* Not designed for use as a free-standing support.

Features:

Sirui P-S Series Monopod

- Three sturdy fold-down support feet that provide additional stability and flexibility. Removable for use as a standard monopod.
- Patented panning grip smoothly rotates 360°.
- Swivels 20° in any direction or locks vertically (patented).
- Adjustable friction control on the swivel ball lets you adjust tension for different weight equipment and resistance requirements
- Patented base locking collar keeps the monopod standing upright.
- Removable feet can be used as a table top tripod.
- Foam grip for solid hold in wet or cold conditions.
- Mounting plate comes with double headed, reversible screw that accommodates 1/4" and 3/8" tripod sockets.
- Rubber foot for use on wooden, stone surfaces. Replace with spike for use outdoors in grass and dirt.
- Lightweight 8 layer 100% Carbon Fiber for added strength, increased load capacity and vibration reduction.

(P224S, 324S, 424S, P-326S & P-426S)

P-S SERIES MONOPODS

Item #	Sirui Model #	Materials	# of Sec.	Max Leg Diam.	Min Leg Diam.	Min Ht in (mm)	Max Ht in (mm)	Weight lb (kg)	Load lb (kg)	MSRP
BSRP204S	P-204S	Aluminum Alloy	4	28	19	27.2 (690)	63 (1600)	2.9 (1.3)	17.6 (8)	\$199.95
BSRP224S	P-224S	Carbon Fiber	4	28	19	27.2 (690)	63 (1600)	2.6 (1.1)	17.6 (8)	\$299.95
BSRP324S	P-324S	Carbon Fiber	4	32	22	28.5 (725)	68.9 (1750)	2.9 (1.3)	22 (10)	\$329.95
BSRP424S	P-424S	Carbon Fiber	4	36	25	30.1 (765)	74.8 (1900)	3.1 (1.4)	26.5 (12)	\$379.95
BSRP326S	P-326S	Carbon Fiber	6	33	15	21.5 (545)	59.1 (1500)	2.9 (1.3)	17.6 (8)	\$399.95
BSRP426S	P-426S	Carbon Fiber	6	36	18.6	22.6 (575)	63 (1600)	3.1 (1.4)	22 (10)	\$459.95

NEW NEW



- P-204S**
Recommended Platforms & Heads: VA-5, VH-10, L-10, VH-90, MP-20
- P-224S**
Recommended Platforms & Heads: VA-5, VH-10, L-10, VH-90, MP-20
- P-324S**
Recommended Platforms & Heads: VH-10, L-10, VH-90, MP-20
- P-424S**
Recommended Platforms & Heads: VH-10, L-10, VH-90, MP-20
- P-326S**
Recommended Platforms & Heads: VA-5, VH-10, L-10, VH-90, MP-20
- P-426S**
Recommended Platforms & Heads: VH-10, L-10, VH-90, MP-20

What's included:
Photo/Video Monopod, (2) removable rubber feet, (1) removable stainless steel spike, 1/4" & 3/8" mounting stud, custom carrying case, shoulder strap, wrist strap, tools, instruction manual, warranty card



Stainless Steel Spike for outdoor use & rubber foot for indoor use

Watch the P-S Video
WATCH VIDEO <http://bit.ly/SiruiP-S>



www.argraph.com

Address: 111 Asia Place, Carlstadt, NJ 07072
Phone: 201.939.7722

Twitter: @argraph



SIRUI 6-YEAR U.S. WARRANTY ONLY HONORED WHEN PURCHASED FROM A U.S. AUTHORIZED DEALER

SIRUI P SERIES PROFESSIONAL MONOPODS



P Series



P-204C
Recommended Ball Heads: G-10X, K-10X, L-10

P-224C
Recommended Ball Heads: G-10X, K-10X, L-10

P-306
Recommended Ball Heads: G-10X, G-20X, K-10X, L-10

P-326
Recommended Ball Head: G-10X, K-10X, G-20X, K-20X

P-324
Recommended Ball Heads: G-20X, K-20X, K-30X, L-10

P-424
Recommended Ball Heads: G-20X, K-20X, K-30, L-10, VH-20, MP-20

Features

1. Retractable stainless steel spike for extra grip during outdoor shooting
2. Foam grip for solid hold in wet or cold conditions
3. The mounting plate comes with a double headed, reversible screw that accommodates 1/4" and 3/8" tripod sockets

For ultimate stability, nothing but a tripod will do. However, there are times when a tripod is not practical or allowed. A monopod offers excellent stability when working with long telephoto lenses and makes a difference in low-light situations. Monopods are easy to carry, can be set up instantly and are ideal when you are working in tight spaces.

You've seen sports photographers on the sidelines with huge lenses - they are given small spaces to shoot from and often need to quickly move from place to place. Using a tripod is not an option under these conditions. Only a monopod will do the job!

SIRUI P-306 and P-326 monopods have 6 sections that extend to 60.6 in. (154 cm) when fully opened, yet, are only 15 in. (38 cm) when closed - small enough to fit in a backpack or photo bag. The **Sirui P-324 and P-424** are 4 section Monopods that extend to 66.9 inches and close to 22". They are designed to support more weight at greater heights.

The entry-level **P-204C/224C** can extend to an impressive 66.9 inches (170cm) and can hold up to 22lb (10kg). The **P-204C/P224C locking knob has been re-tooled** so that they are smaller in order to give the monopod a more sleek feel. Available in economical aluminum (P-204C) or lightweight, 8 layer Carbon Fiber (P-224C), these 4-section monopods are an excellent choice for compact DSLRs and camcorders.



L-10

What's included:
Monopod, wrist strap, tool, belt hook, instruction manual, warranty card, Compass (on P306 & P326)

P SERIES MONOPODS

Item #	Sirui Model #	Materials	# of Sec.	Max Leg Diam.	Min Leg Diam.	Mono Min Ht in (mm)	Mono Max Ht in (mm)	Weight lb (kg)	Load lb (kg)	MSRP
BSRP204C	P-204C	Aluminum Alloy	4	28	19	20.5 (520)	66.9 (1700)	1.1 (0.5)	22 (10)	\$ 69.95
BSRP224C	P-224C	Carbon Fiber	4	28	19	20.5 (520)	66.9 (1700)	0.9 (0.4)	22 (10)	\$119.95
BSRP306	P-306	Aluminum Alloy	6	32	16	15 (380)	61.4 (1560)	1.1 (0.5)	17.6 (8)	\$79.95
BSRP326	P-326	Carbon Fiber	6	32	16	15 (380)	61.4 (1560)	0.9 (0.4)	22 (10)	\$139.95
BSRP324	P-324	Carbon Fiber	4	32	22	22 (560)	66.5 (1690)	1.3 (0.6)	22 (10)	\$149.95
BSRP424	P-424	Carbon Fiber	4	36	25	22 (560)	66.9 (1700)	1.3 (0.6)	33.1 (15)	\$169.95
		Description		Diameter		Height				
BSRL10	L-10	Monopod Tilt Head		in (mm)	1.7 (43)	in (mm)	3.4 (87)	7.7 (0.33)	33.1 (15)	\$139.95



www.argraph.com

Address: 111 Asia Place, Carlstadt, NJ 07072
Phone: 201.939.7722

Twitter: @argraph



SIRUI 6-YEAR U.S. WARRANTY ONLY HONORED WHEN PURCHASED FROM A U.S. AUTHORIZED DEALER

SIRUI VA SERIES ARCA COMPATIBLE PROFESSIONAL FLUID VIDEO HEAD



VA Series

Compact design • Professional Quality
Made for today's DSLR/Video Systems

VA-5

NEW VA-5



Arca Compatible Video Head

To create beautiful, professional videos, you need smooth movements and transitions. SIRUI VA-5 Professional Fluid Video Heads have a fluid system designed to produce smooth pans and tilts. And an internal spring-assisted counter-balance mechanism provides added support, smoother tilt movements and protection to your equipment.

Forward/backward camera position adjustments for balance are fast and easy. And the dual safety lock system prevents the camera from falling off when the primary locking mechanism is loosened. Push the secondary release button to remove the camera from the video head.

The precision-machined aluminum VA-5 weighs only 1.3lb (.6kg), it can easily handle camera systems (camera, lens, grip, lights, etc.) weighing up to

To make horizontal alignment of the head extra easy, there are 2 bubble levels - one on the base of the head to align the tripod and one on top of the video head to align the camera (a SIRUI first!).

The VA-5 is also perfect for use with spotting scopes for bird-watching. It includes a TY-70 Quick Release Plate and will accept all SIRUI TY-series Quick Release Plates and many other Arca-compatible quick release plates.

Additional Quick Release Plates



Features

- Precision machining and forged aircraft aluminum bodies provide rugged, reliable heads. Weighs only 1.3lb (.6kg!) Supports up to 6.6 lb (3kg)
- Smooth fluid movements combined with an advanced balancing system
 - 360° horizontally and +90/-70° vertically
- Two bubble levels for critical alignment

VA FLUID VIDEO HEAD

Item #	Sirui Model #	Materials	in (mm)	lb (kg)	lb (kg)	MSRP
BSRVA5	VA-5	Aluminum Alloy	11.8 (300) x 4.7 (120) x 3.17 (83)	1.3 (0.6)	6.6 (3)	\$249.95

Additional Quick Release Plates

BSRTY50	TY-50	Aluminum Alloy	1.97 (50) x 1.54 (39) x 0.42 (10.8)	1.1 (31.4)		\$ 40.00
BSRTY50X	TY-50X	Aluminum Alloy	1.97 (50) x 2.15 (54.5) x 0.37 (9.5)	1.3 (36.9)		\$ 40.00
BSRTY60	TY-60	Aluminum Alloy	2.36 (60) x 1.93 (49) x 0.42 (10.8)	1.4 (39.6)		\$ 45.00
BSRTY60X	TY-60X	Aluminum Alloy	2.36 (60) x 2.15 (54.5) x .37 (9.5)	1.6 (45.4)		\$ 45.00
BSRTY70	TY-70	Aluminum Alloy	2.76 (70) x 1.54 (39) x 0.42 (10.8)	1.3 (37.2)		\$ 45.00
BSRTY70X	TY-70X	Aluminum Alloy	2.76 (70) x 2.15 (54.5) x .37 (9.5)	1.7 (48.2)		\$ 45.00
BSRTY702	TY-70-2	Aluminum Alloy	2.76 (70) x 2.36 (60) x 0.42 (10.8)	2.1 (60.3)		\$ 48.00
BSRTYLP40	TY-LP40	Aluminum Alloy	2.56 (65) x 1.54 (39) x 0.42 (10.8)	1.4 (39.6)		\$ 29.95
BSRTYLP75	TY-LP75	Aluminum Alloy	2.91 (74) x 1.54 (39) x 0.42 (10.8)	1.6 (45.4)		\$ 48.00

What's included:
Handle, TY-70 Quick release plate
(Arca compatible)
instruction manual, warranty card

WATCH VIDEO **Watch the**
<http://bit.ly/SiruiVA5>



www.argraph.com

Address: 111 Asia Place, Carlstadt, NJ 07072
Phone: 201.939.7722

Twitter: @argraph



SIRUI 6-YEAR
U.S. WARRANTY ONLY
HONORED WHEN
PURCHASED FROM A U.S.
AUTHORIZED DEALER

SIRUI VH SERIES PROFESSIONAL FLUID VIDEO HEAD



VH
Series

Compact design • Professional Quality
Made for today's DSLR/Video Systems

VH-10/VH-15



VH-15
Shown

Professional Fluid Video Heads

The world of videography has quickly changed over the past few years. Many photographers have realized the need and advantage of shooting videos. The introduction of DSLRs and lower priced modular video cameras that can produce professional quality videos, has accelerated this trend.

Along with the growth of video has come the need for high quality video heads that are compact in size, but provide the control needed to produce videos with smooth pans, controlled tilts and seamless transitions. The SIRUI VH Series Professional Fluid Video Heads are compact video heads designed for today's photo/videographers.

The precision-machined aluminum **VH-10 weighs only 1.98lb (.9kg)**, it can easily handle camera systems (camera, lens, grip, lights, etc.) weighing up to 13.2lb (6kg)! And to keep everything level, it has a 4.4lb (2kg) built-in counterbalance system. It's larger sibling, the **VH-15, weighs only 3.7lb (1.7kg)**, it can easily handle camera systems (camera, lens, grip, lights, etc.) weighing up to 22lb (10kg)! The built-in counterbalance for the VH-15 is 8.8lb (4kg).

The panning resistance is preset to provide amazingly smooth 360° pans and can be locked in position when you need precise framing. The SIRUI designed fluid head tilting mechanism lets you steplessly dial in the amount of resistance you need - producing the smooth, professional looking movement you demand, whether you're working with a heavy or lightweight camera system.

When the Tilt Control Knob has no resistance, the head can quickly be moved to the desired angle. The counterbalance mechanism helps to bring the head back to a neutral position when you tilt the head - this helps camera balance and reduces unsteady tilt sequences, even when no resistance is set. As you increase the resistance, or drag, you noticeably smooth out the look of your tilts. When you combine the smooth panning motion with properly selected drag or tilting, you will achieve a very fluid, professional look and feel to your videos. You can also lock panning and/or tilting, so no movement occurs at all. Since you will be using different camera/lens combinations, you will need to make forward and backward camera position adjustments on the video head, for proper balance and alignment. The VH-10/VH-15 Quick Release Platform can do this very quickly and easily. It has a dual safety lock system to prevent the camera from accidentally falling off when the primary locking mechanism is loosened. You must push the secondary release button to remove the camera from the video head. Very safe!

To make horizontal alignment of your camera system simple, **there are 2 bubble levels on the SIRUI VH-10/VH-15 Video Heads** – one on the base of the head (to make sure your tripod is properly aligned) and one on top of the head (to check alignment of the camera).

Features

- Both models offer precision machining and forged aircraft aluminum bodies that provide rugged, reliable heads.
- **VH-10** weighs only 1.98lb (.9kg!) Supports up to 13.2 lb (6kg)
- **VH-15** weighs only 3.7lb (1.7kg!) Supports up to 22 lb (10kg)
- Smooth fluid movements combined with an advanced balancing system
 - 360° horizontally and +90/-70° vertically
- Two bubble levels for critical alignment

What's included:
Handle, Quick release plate
(Manfrotto compatible)
instruction manual, warranty card

Accessories



VH SERIES VIDEO HEADS

Item #	Sirui Model #	Materials	Dimensions in (mm)	Weight lb (kg)	Load lb (kg)	MSRP
BSRVH10	VH-10	Aluminum Alloy	14.4 (365) x 5.7 (145) x 3.7 (95)	2 (0.9)	13.2 (6)	\$299.95
BSRVH15	VH-15	Aluminum Alloy	15.8 (402) x 6.73 (171) x 4.8 (122)	3.7 (0.9)	22 (10)	\$399.95
Additional Accessories						
BSRVH125D	VH-125	Aluminum Alloy	4.92 (125) x 1.97 (50) x 0.47 (12)	0.25 (0.007)		\$ 69.95
BSRVP90	VP90	Aluminum Alloy	3.5 (90) x 1.97 (50) x 0.47 (12)	2.3 oz (65g)		\$ 52.95
BSRVP350	VP-350	Aluminum Alloy	16.5 (420) x 3.54 (90) x 5.71 (95)	0.2 (0.1)		\$134.95
BSRRX75A	RX-75A	75mm Adapter Bowl	Dia: 3.3 (85) Height: 1.5 (38)	0.3 lb (0.14)	39.7 (18)	\$50.00
BSRRX75B	RX-75B	75mm Leveling Ball Set	Dia: 3.6 (92) Height: 8.1 (205)	0.9 (0.4)	39.7 (18)	\$100.00
BSRY75A	Y-75A	75mm Adapter Bowl	Diameter: 3.6 (91) Height: 2.9 (1.1)	0.2 (1)	39.7 (18)	\$46.95
BSRY75B	Y-75B	75mm Leveling Ball Set	Diameter: 3.6 (91) Height: 7.31 (186)	0.9 (4)	39.7 (18)	\$89.95
BSRLE60	LE-60	Leveling Base	Diameter: 2.4 (60mm)	10.2 oz (290g)		\$149.95

ARGRAPH
CORP.

www.argraph.com

Address: 111 Asia Place, Carlstadt, NJ 07072
Phone: 201.939.7722

Twitter: @argraph

Watch the
VH Series Video
WATCH VIDEO <http://bit.ly/SiruiVH-Series>



What Makes Sirui Professional Tripods Your Best Choice?

Forged for greater Strength and Reduced Weight

Instead of using traditional casting methods typical of tripod construction, Sirui is a pioneer in using forging technology in manufacturing. During the forging process, the deformation and recrystallization of metal causes the structure of the metal to be more welded together and compact - greatly increasing its strength-to-weight ratio. This enables Sirui to build products with exceptional strength and durability, that are surprisingly light.

Forging ensures the integrity of metallic fibers so that it remains consistent inside & out. Good integrity allows for a longer lifetime as well as better performance. In fact, the forging process can create parts that are much stronger than those manufactured by any other metalworking process.

Forged



The added strength of forging allows thinner, lighter components.

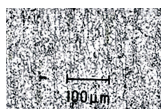

Micro structure of the metal after forging. The consistent structure provides very impressive strength.

Cast



Others' cast components must be thicker and heavier to provide the same strength.

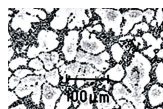

Micro structure of the metal after casting process. Inconsistent structure with many gaps and weaknesses.

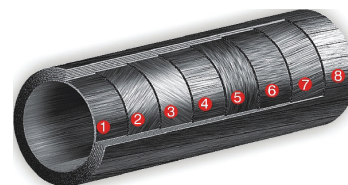

8 or 10 Layers of Carbon Fiber for Superior Load Capacity

SIRUI is one of the few manufacturers who make their own Carbon fiber leg tubes. The use of 100% carbon fiber and 8 or 10 cross pattern layers, makes SIRUI tripods and monopods capable of supporting impressive load capacities, while providing a lightweight product. In addition to providing high strength and low weight, carbon fiber is also highly resistant to temperature changes, friction (no need for lubrication) and corrosion.



Custom Anodized Surface Treatment

All SIRUI products undergo a special anodized surface treatment that makes all metal surfaces highly resistant to wear and increases durability and weather resistance. Anodizing is an environmentally safe electrochemical process.

This also prepares the surface to provide better adhesion of colored finishes.

Temperature Tolerance Test

Photographers often work in extreme environments, like blazing deserts or sub-zero mountaintops. It is vital that your equipment works under these conditions. That is why we torture-test all of our products - under conditions that far exceed what most people will ever experience (-40° ~ 212°F/-40° ~ 100°C). SIRUI is the first Chinese manufacturer to continuously perform the 4-hour test (equal to many years of use) on all products.



Certified Longevity Tests For Quality & Reliability

To confirm the quality and reliability of SIRUI tripods (and our dedication to details), an independent testing lab (SGS) subjected the leg angle lock spring mechanisms to exhaustive longevity tests. The test reports show that even after 100,000 actuations, the springs continued to perform perfectly!



Twist or Flip Leg Locks

To lock the legs of SIRUI tripods, we utilize SIRUI designed 1/2 turn Twisting Leg Locks or fast-action Flip Leg Locks, for maximum reliability and stability.

Precision Leg Tubes

The difference in diameter of ET/EN/NX/TX/R/SN series tripod tubes is only 3 mm. Thanks to precision manufacturing, the legs open and close easily, while the small diameter difference provides added leg stability.

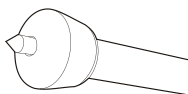
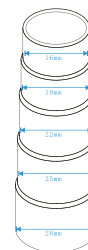

Retractable Steel Spikes

For added stability outdoors, SIRUI 2/3/4 Series tripods and monopods have retractable stainless steel spikes, stored inside the slip-resistant rubber feet.

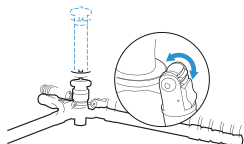

Free Short Center Column

TX/ET/EN/NX/MX/SN/R3/R4 series tripods allow low angle shooting for unique perspectives and macro photography. And most models include a free short center column (excludes R series and T-005/025) or split center column (EN/NX/MX) for added flexibility.

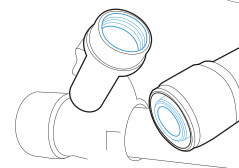

Non-Twist Center Column/Legs

All SIRUI center columns and legs have keyed, grooved channels, that prevent twisting - providing additional stability and safety for your photographic equipment.

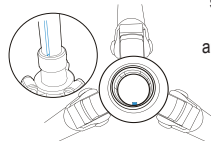

Convert to Monopod

The detachable leg of SN/EN/NX/MX series tripods lets you transform your tripod into a monopod! Reduces the amount of equipment you need to carry and makes your camera bag or backpack lighter.



Sirui 6 Year Warranty
Sirui backs up its products
with a 6 Year Warranty!



What Makes Sirui Professional Heads Your Best Choice?

CAM Produced

Each assembled component of SIRUI Ball Heads is produced by CAM (Computer Aided Manufacturing) - the ultimate in precision manufacturing techniques.

Aviation Grade Aluminum Alloy

SIRUI ball heads are made of aviation quality aluminum alloy 7075-T6 and 6067-T6 for long life and maximum strength.

SIRUI Precision Manufacturing - 0.01mm tolerances!

SIRUI uses a special manufacturing technique that produces the support ball with tolerances to within 0.01mm of a perfect sphere. This uncompromising precision guarantees superior performance and smooth operation for any type of 35 mm, DLSR, medium or large format camera system.



Sirui Designed Dual Bevel Ball Head Locks

The interior locking system in SIRUI Ball Heads uses SIRUI designed double bevel locks for superior locking performance and reliability. Most ball heads only use a single, less efficient interior locking system.

Patented Safety Lock

The patented safety lock design, and SIRUI quick release plates, effectively prevent the camera from accidentally sliding off of the ball head. And most Arca-compatible quick release plates can be used on SIRUI Ball Heads. (Note: safety lock design not available from other brands).



Custom Anodized Surface Treatment

All SIRUI products undergo a special anodized surface treatment that makes all metal surfaces highly resistant to wear and increases durability and weather resistance. Anodizing is an environmentally safe electrochemical process. This also prepares the surface to provide better adhesion of colored finishes.



Sirui GX Series Ball Heads

Winner of Germany's Foto Magazin Tripod Quality Test - M3204
 Winner of Camera Magazine Innovative Imaging Product of the Year - TX Series
 5 of the Top 10 Ball Heads in Germany's 'Traumflieger Test of 33 Ball Heads' are Sirui Ball Heads

Panning base

The panning base is designed with a 360 degree dial. Having a separate panning base lock knob provides greater accuracy for panning and panoramic shooting.

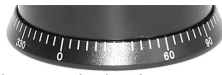

High Quality Quick Release Plates

All SIRUI TY Series Quick Release Plates are made from forged aluminum alloy. The forging technique produces high-density metals with much greater strength than die-cast methods.

Model Specific Quick Release Plates

When using long lenses or heavy cameras, it is very important to make sure that there is a perfect fit between the camera and quick release plate. For that reason, SIRUI offers a selection of quick release plates for specific types and models of cameras.



The Special QR Plates are model specific for a perfect fit.



GX Series Ball Heads



1. Separate control knobs for panning, locking and friction control.
2. Dual built-in bubble-levels help make horizontal & vertical alignment fast & easy.
3. Sirui's unique locking mechanism provides unequalled locking force even with **loads up to 44lb (20kg)!**

KX Series Ball Heads



1. Separate control knobs for panning and locking. Friction knob is conveniently located on the main locking knob.
2. Triple-bubble levels allow precise horizontal leveling for critical shooting solutions.
3. Sirui's unique locking mechanism provides unequalled locking force even with **loads up to 77lb (35kg)!**



Conveniently hand tighten or use the included allen wrench to secure your camera/lens onto the Quick Release Plate



Comes with protective storage case



TY Series QR plates are designed with slide-stopping rubber mats to prevent the camera/lens from moving while tightening the screw.



Sirui 6 Year Warranty
 Sirui backs up its products with a 6 Year Warranty!



www.argraph.com

Address: 111 Asia Place, Carlstadt, NJ 07072
 Phone: 201.939.7722

Twitter: @argraph



SIRUI 6-YEAR U.S. WARRANTY ONLY HONORED WHEN PURCHASED FROM A U.S. AUTHORIZED DEALER

SIRUI S-N SERIES PROFESSIONAL TRIPODS



S-N Series

S-N series flat style tripods have an extremely functional appearance, are only 1.6 inches (4 cm) thick when folded flat and are small enough to be easily carried and stored in a suitcase or backpack. All S-N series tripods have 8 layer carbon fiber legs for maximum load handling and light weight.

Flat design + versatility = perfect choice for travel photography

For added load capacity and stability, this new generation of flat style tripods has increased minimum leg tube diameters.

The reversible center column lets you mount your camera at a unique angle for low level or ground level shooting

S-N 2 Series tripods have retractable stainless steel spikes for outdoor photography.

S-1204N
Recommended Ball Heads: K-10X, G-10X

S-1205N
Recommended Ball Heads: K-10X, G-10X

S-2204N
Recommended Ball Heads: K-20X, G-20X

S-2205N
Recommended Ball Heads: K-20X, G-20X

The hook at the bottom of the center column allows you to hang additional weight (sand bag, camera bag, etc.) under the tripod for added stability.



Flat design makes it easy to carry and store in backpacks and carry-ons.

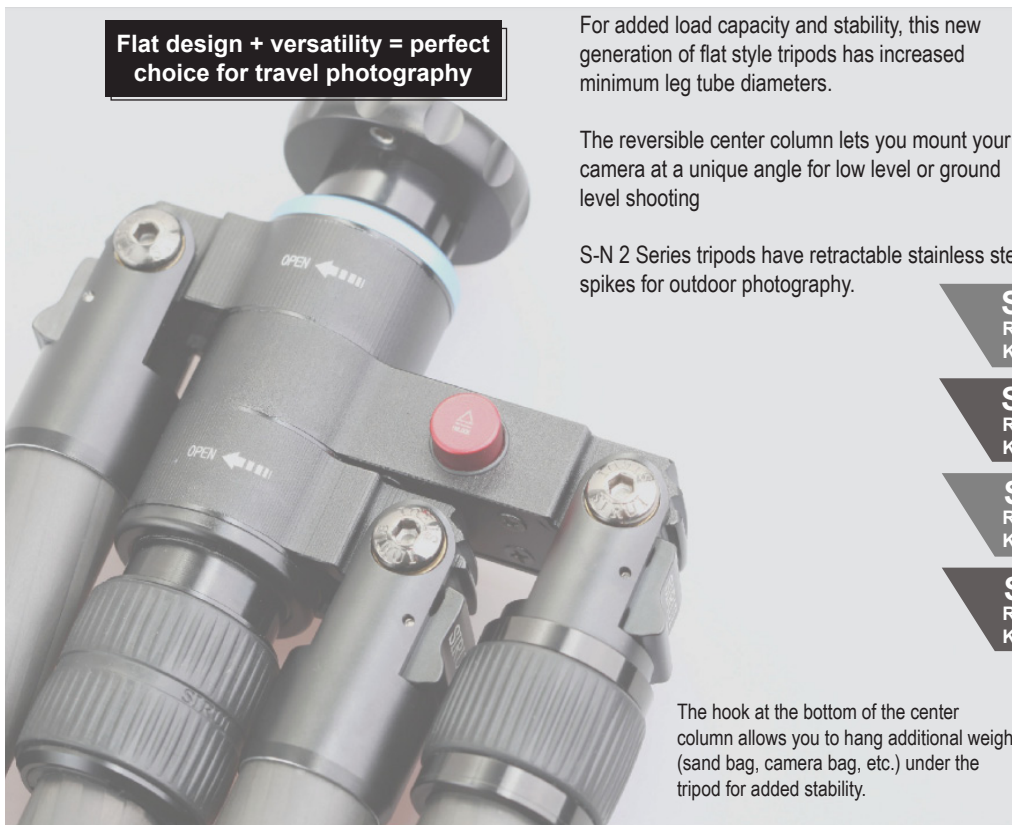

For added versatility, S-N series tripods are designed with a detachable leg that converts into a monopod - extremely convenient when tripods are not allowed or when shooting in narrow areas. And the center column can be attached for more height. The legs have two angle positions for use on uneven terrain and for low angle macro shooting (a short center column is included). These and many other valuable features make S-N tripods excellent for travel photography.



Newly designed locking system

The SIRUI S-N series tripod has a unique leg position locking system that clicks in place when the tripod is opened. This guarantees that the tripod legs will be properly positioned - providing a rugged, stable support for your equipment. Simply open the tripod in the direction of the arrows until it clicks into place. When you're done shooting, press the red unlock button and close the tripod flat.

What's included:
Short center column, custom case, padded shoulder strap, tools, instruction manual, warranty card

S-N SERIES TRIPODS

Item #	Sirui Model #	Materials	Max # of Sec.	Min Leg Diam.	Leg Diam.	Min Ht in (mm)	Max Ht in (mm)	Max Ht Ext. in (mm)	Retract Ht in (mm)	Mono Max Ht in (mm)	Mono Min Ht in (mm)	Weight lb (kg)	Load lb (kg)	MSRP
BSRS1204	S-1204-N	Carbon Fiber	4	25	16	6.9 (175)	45.1 (1145)	54.1 (1375)	18.5 (470)	59.6 (1515)	15.4 (390)	2.4 (1.1)	26.5 (12)	\$570.95
BSRS1205	S-1205-N	Carbon Fiber	5	25	13	6.7 (170)	47.2 (1200)	55.5 (1410)	17.7 (450)	60.6 (1540)	14.4 (365)	2.4 (1.1)	26.5 (12)	\$604.95
BSRS2204	S-2204-N	Carbon Fiber	4	28	19	6.9 (175)	45.5 (1155)	54.1 (1375)	18.9 (480)	59.8 (1520)	15.7 (400)	3.1 (1.4)	33.1 (15)	\$604.95
BSRS2205	S-2205-N	Carbon Fiber	5	28	16	7.1 (180)	47.8 (1215)	53.9 (1370)	17.7 (450)	60.2 (1530)	14.6 (370)	3.1 (1.4)	26.5 (12)	\$639.95



www.argraph.com

Address: 111 Asia Place, Carlstadt, NJ 07072
Phone: 201.939.7722

Twitter: @argraph



SIRUI 6-YEAR
U.S. WARRANTY ONLY
HONORED WHEN
PURCHASED FROM A U.S.
AUTHORIZED DEALER

SIRUI G-X, C-X, K-X & L SERIES PROFESSIONAL BALL HEADS



Ball Heads

G-X SERIES BALLHEAD



**G-10X
Ball Head**

1. Separate adjustment knobs for panning, friction control and locking for maximum control and flexibility.
2. The **G-10X/20X** have two bubble levels (one on top and one on the clamp locking knob) for fast horizontal and vertical alignment.
3. Sirui's unique locking mechanism provides unequalled locking force even with **loads up to 44lb (20kg)!**



Watch the
C-10 Video

WATCH VIDEO <http://bit.ly/1vMYErH>



**C-10X
Ballhead**



**L-10
Tilt Head**

G-X, C-X, K-X & L SERIES BALLHEADS

Item #	Sirui Model #	Ball Dia	Base Dia	Height in (mm)	Weight lb (kg)	Load lb (kg)	QR Plate included	MSRP
BSRG10KX	G-10KX	29	Ø 42	3.5 (90)	0.7 (0.31)	39.7 (18)	TY-50X	\$135.95
BSRG20KX	G-20KX	36	Ø 50	3.9 (100)	0.8 (0.38)	44.1 (20)	TY-50X	\$145.95
BSRK10	K-10X	33	Ø 49	3.8 (96)	0.9 (0.41)	44.1 (20)	TY-50X	\$159.95
BSRK20	K-20X	38	Ø 54	4 (101)	0.9 (0.41)	55.1 (25)	TY-50X	\$174.95
BSRK30	K-30X	44	Ø 61	4.3 (109)	1.2 (0.55)	66.1 (30)	TY-60X	\$189.95
BSRK40	K-40X	54	Ø 75	4.9 (124)	0.7 (0.31)	77.2 (35)	TY-70X	\$219.95
BSRC10	C-10X	29	Ø 42	3.3 (85)	0.5 (0.22)	28.7 (13)	TY-C10	\$ 99.95
BSRL10	L-10		Ø 43	3.4 (87)	0.7 (0.33)	33.1 (15)	TY-60	\$139.95

**Superior performance at
an unbeatable price.**

WHY SIRUI BALL HEADS?

Each assembled component of SIRUI Ball Heads is produced by CAM (Computer Aided Manufacturing) - **the ultimate in precision manufacturing techniques.**

SIRUI ball heads are made of **aviation quality aluminum alloy** 7075-T6 and 6067-T6 for long life and maximum strength.

SIRUI uses a special manufacturing technique that produces the support ball with tolerances to within 0.01mm of a perfect sphere. This uncompromising precision guarantees **superior performance and smooth operation** for any type of 35mm DSLR or medium format camera system.

The interior locking system in SIRUI Ball Heads uses SIRUI designed **double bevel locks for outstanding locking performance and reliability.** Most ball heads only use a single, less efficient interior locking system.

The panning base is designed with a 360° dial. Having a **separate panning base lock knob** provides greater accuracy for panning and panoramic shooting. The patented safety lock design, and SIRUI quick release plates, effectively prevent the camera from accidentally sliding off of the ball head when you slightly loosen the Quick Release Clamp (to adjust the positioning of your equipment). And most quick Arca release plates can be used on SIRUI Ball Heads (Note: safety lock feature not applicable with other brand plates).

The **patented safety lock design**, and SIRUI quick release plates, effectively prevent the camera from accidentally sliding off of the ball head. And most quick release plates can be used on SIRUI Ball Heads (Note: safety lock design not available from other brands).

The **custom anodized surface treatment** makes all metal surfaces highly resistant to abrasions and produces a beautiful appearance.

All Sirui Ball Heads are Arca-Compatible

K-X SERIES BALLHEAD



**K-10X
Ball Head**

1. Separate control knobs for panning and locking. Friction knob is conveniently located on the main locking knob.
2. Triple bubble levels allow precise horizontal leveling for critical shooting situations.
3. Sirui's unique locking mechanism provides unequalled locking force even with loads up to 77lb (35kg)!

**K-40X Named
"Best Value" by
dpreview.com**
Digital Photography Review

<http://bit.ly/SiruiK-40XDPRReview>

Winner of Germany's
Foto Magazin Tripod
Quality Test - M3204

Winner of Camera Magazine
Innovative Imaging Product
of the Year - TX Series

5 of the Top 10 Ball Heads
in Germany's "Traumflieger
Test of 33 Ball Heads"
are Sirui Ball Heads



ARGRAPH
CORP.

www.argraph.com

Address: 111 Asia Place, Carlstadt, NJ 07072
Phone: 201.939.7722

Twitter: @argraph



**SIRUI 6-YEAR
U.S. WARRANTY ONLY
HONORED WHEN
PURCHASED FROM A U.S.
AUTHORIZED DEALER**

SIRUI TY SERIES QUICK RELEASE PLATES, PLATFORMS, L-BRACKETS, BASES



TY Series

All SIRUI TY Series Quick Release Plates are made from forged aluminum alloy. The forging technique produces high-density metals with much greater strength than die-cast methods. When using long lens or heavy cameras, it is very important to make sure that there is a perfect fit between the camera and quick release plate.

For that reason, SIRUI offers a selection of quick release plates for different types and models of cameras.

Standard SIRUI TY Series QR plates are designed with **slide-stopping rubber mats** to prevent the camera/lens from moving while tightening the screw. The new **SIRUI TY-X Series** plates have a **special slot for use with today's popular camera straps** – you don't need to remove the strap to attach the QR plate to the ball head.

All plates take advantage of the **patented SIRUI safety lock design**, that prevents your camera from accidentally sliding off of the head when you slightly loosen the Quick Release Clamp (to make adjustments to the positioning of your equipment). All SIRUI TY Series Quick Release Plates are Arca-compatible. Many SIRUI TY Quick Release plates have slide stopping rubber mats that are designed to prevent the camera from shifting or twisting as you move the ball head or position your camera in a vertical position. There is also a series of specialized QR plates that are camera model specific, for a perfect fit!



- TY-BG
- TY-C10
- TY-D3
- TY-D700
- TY-D800
- TY-LP-40
- TY-LP-70
- TY-LP75
- TY-50
- TY-50E
- TY-50X
- TY-5DII
- TY-5DIII
- TY-60
- TY-60X
- TY-70
- TY-70-2
- TY-70X
- TY-350
- PH-120

SIRUI QUICK RELEASE PLATES

Item #	Sirui Model #	Size in (mm)	Weight oz (gr)	For Camera Model	For Head	MSRP
BSRTYBG	TY-BG	2.05 (52) x 2.17 (55) x .55 (14)	1.3 (37.2)	Most DSLR w/Batter Grip	G/K Series	\$ 52.95
BSRTYC10	TY-C10	1.18 (30) x 1.54 (39) x .31 (8)	0.6 (17)	All Cameras	C-10X	\$ 19.95
BSRTYBG	TY-D3	2.05 (52) x 2.17 (55) x .55 (14.6)	1.7 (48.2)	Nikon D3	G/K Series	\$ 48.00
BSRTYD700	TY-D700	2.36 (60) x 1.74 (44.2) x .425 (10.8)	1.1 (31.5)	Nikon D700	G/K Series	\$ 48.00
BSRTYD800	TY-D800	2.36 (60) x 2.15 (54.5) x .425 (10.8)	1.3 (37.2)	Nikon D800	G/K Series	\$ 52.00
BSRTYLP40	TY-LP-40	2.56 (65) x 1.54 (39) x .425 (10.8)	1.4 (39.6)	Mirrorless Cameras	G/K Series	\$ 29.95
BSRTYLP70	TY-LP-70	3.54 (90) x 2.72 (69) x .425 (10.8)	2.9 (83)	All Cameras	G/K Series	\$ 44.95
BSRTYLP75	TY-LP-75	2.91 (74) x 1.54 (39) x .425 (10.8)	1.6 (45.4)	Long Telephoto Lenses	G/K Series	\$ 48.00
BSRTY50	TY-50	1.97 (50) x 1.54 (39) x .425 (10.8)	1.1 (31.4)	All Cameras	G10X/K20X/E10	\$ 40.00
BSRTY50E	TY-50E	1.97 (50) x 1.54 (39) x .37 (9.5)	1.0 (29.6)	All Cameras	G10X/K20X/E10	\$ 30.00
BSRTY50X	TY-50X	1.89 (48) x 1.75 (44.5) x .43 (11)	1.3 (36.9)	All Cameras/Strap Slot	G10X/K20X/E10	\$ 40.00
BSRTY5D	TY-5DII	2.05 (52) x 2.17 (55) x .55 (14)	1.0 (28.5)	Canon 5D MarkII	G/K Series	\$ 48.00
BSRTY5D3	TY-5DIII	2.45 (62.2) x 1.98 (50.4) x .49 (12.5)	1.4 (39.6)	Canon 5D MarkIII	G/K Series	\$ 52.00
BSRTY60	TY-60	2.36 (60) x 1.93 (49) x .42 (10.6)	1.4 (39.6)	All Cameras	G20X/K20X	\$ 45.00
BSRTY60X	TY-60X	2.36 (60) x 2.15 (54.5) x .37 (9.5)	1.6 (45.4)	All Cameras/Strap Slot	G20X/K20X	\$ 45.00
BSRTY70	TY-70	2.76 (70) x 1.54 (39) x .425 (10.8)	1.3 (37.2)	All Cameras	G10/K20/K30	\$ 45.00
BSRTY702	TY-70-2	2.76 (70) x 2.36 (60) x .425 (10.8)	2.1 (60.3)	All Cameras	K30/K40	\$ 48.00
BSRTY70X	TY-70X	2.76 (70) x 2.15 (54.5) x .37 (9.5)	1.7 (48.2)	All Cameras/Strap Slots	G10/K20	\$ 45.00
BSRTY350	TY-350	18.9 (482) x 3.54 (90) x 6.1 (155)	16.2 (460)	Long Telephoto Lenses	PH-20/K30/K40	\$134.95
BSRPH120	PH-120	4.72 (120) x 1.53 (39) x .425 (10.8)	2.6 (73.7)	Long Telephoto Lenses	PH-20	\$ 59.95



Address: 111 Asia Place, Carlstadt, NJ 07072
Phone: 201.939.7722

www.argraph.com

Twitter:@argraph



SIRUI 6-YEAR
U.S. WARRANTY ONLY
HONORED WHEN
PURCHASED FROM A U.S.
AUTHORIZED DEALER

SIRUI TY SERIES QUICK RELEASE PLATES, PLATFORMS, L-BRACKETS, BASES



TY
Series



SIRUI L-BRACKETS

TY-D600L

TY-D800L

TY-D4L

TY-5DIIIIL

TY-1DXL

TY-6DLBG

TY-5DIIIILBG

NEW!

NEW!

NEW!

NEW!

NEW!

NEW!

NEW!



TY-D600L



TY-D800L



TY-D4L



TY-5DIIIIL



TY-1DXL



TY-6DLBG



TY-5DIIIILBG

Item #	Sirui Model #	Size in (mm)	Weight oz (gr)	For Camera Model	For Head	MSRP
BSRTYD60L	TY-D600L	4.3 (110) x 2.4 (61) x 3.11 (79)	2.5 (70)	Nikon D600	G/K Series	\$119.95
BSRTYD80L	TY-D800L	4.5 (115) x 2.4 (61) x 3.31 (84)	2.8 (79)	Nikon D800	G/K Series	\$119.95
BSRTYD4L	TY-D4L	4.8 (122) x 3.43 (87) x 4.96 (126)	4.6 (131)	Nikon D4	G/K Series	\$149.95
BSRTY5D3L	TY-5DIIIIL	4.5 (114) x 2.04 (52) x 3.31 (84)	3.2 (91)	Canon 5D Mark III	G/K Series	\$119.95
BSRTY1DXL	TY-1DXL	4.6 (118) x 3.2 (82) x .425 (10.8)	6 (169)	Canon 1DX	G/K Series	\$149.95
BSRTY6DLB	TY-6DLBG	4.3 (110) x 3.3 (85) x 4.65 (111.8)	4.9 (139)	Canon 6D w/Battery Grip	G/K Series	\$149.95
BSRTY5D3B	TY-5DIIIILBG	4.5 (114) x 2.4 (61) x 3.1 (79)	2.7 (71.1)	Canon 5D Mark III w/ Battery Grip	G/K Series	\$149.95

SIRUI QUICK RELEASE BASES & PLATFORM



NEW! LE-60
Leveling Base



NEW! PA-20
Panning Base



MP-20
Quick Release

LE-60

PA-20

MP-20

Item #	Sirui Model #	Size in (mm)	Weight oz (gr)	For Camera Model	Usage	MSRP
BSRLE60	LE60	2.4 (60)	10.2 (290)	All Cameras	All Tripods	\$149.95
BSRPA20	PA20	3.78 (96) x 2.44 (62) x 1.1 (28)	0.3 lb (0.14 kg)	All Cameras	Arca Compatible	\$119.95
BSRMP20	MP20	3.39 (86) x 2.2 (55.8) x .71 (18)	2.8 lb (78.5 kg)	All Cameras	All Tripods	\$ 52.95

SIRUI MANFROTTO COMPATIBLE VIDEO PLATES & PLATFORMS



NEW! VP-90



VP-125



VP-350



VH-90



VH-125

VP-90

VP-125

VP-350

VH-90

VH-125

Item #	Sirui Model #	Size in (mm)	Weight oz (gr)	For Camera Model	For Head	MSRP
BSRVP90	TY-VP90	3.54 (90) x 1.97 (50) x 0.47 (12)	2.3 (65.6)	All Cameras	VH Series	\$52.95
BSRVP125X	TY-VP125	4.92 (125) x 1.97 (50) x 0.47 (12)	4.2 (119)	All Cameras	VH Series	\$69.95
BSRVP350	TY-VP350	16.5 (420) x 3.5 (90) x 5.71 (145)	16.4 (465)	Long Telephoto Lenses	VH Series	\$134.95
BSRVH90	TY-VH90	4.92 (125) x 4.02 (102) x 0.91 (23)	20.5 (580)	All Cameras	Not Applicable	\$99.95
BSRVH125D	TY-VH125	4.92 (125) x 1.97 (50) x 0.47 (12)	4.2 (119)	All Cameras	VH Series	\$69.95

ARGRAPH
CORP.

www.argraph.com

Address: 111 Asia Place, Carlstadt, NJ 07072
Phone: 201.939.7722

Twitter: @argraph